

Data Sheet



Article number: 12621000050700

Description: Threaded pin 621 000 050.700
For M5

Measures

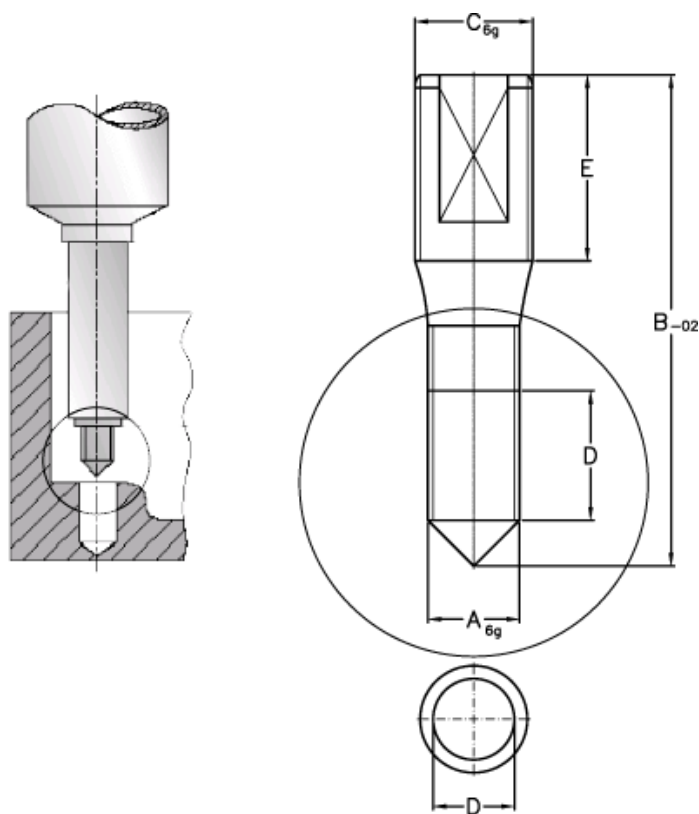

A = M5
B = 91.0
C = M8
D = 15.0
E = 20